

Cod. TM01

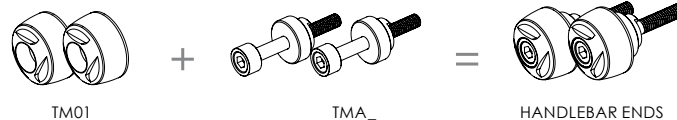

Mounting kit sold separately / Kit attacchi venduti separatamente

Cod. TMA_



MODEL	CODE
"Extreme" handlebars ends Terminali manubrio "Extreme"	TM01

- Material: aluminum alloy, 60gr
- Replace the original handlebar ends
- Recommended for street use
- Reduce the vibrations of the handlebar

- Materiale: lega di alluminio, 60gr
- Sostituiscono i terminali manubrio originali
- Consigliati per uso stradale
- Diminuiscono le vibrazioni del manubrio

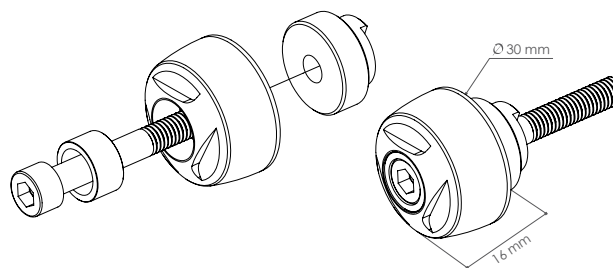
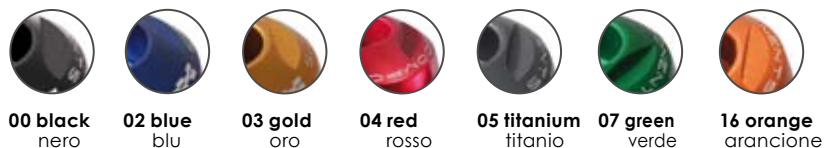

NOTE

TMA10 adaptable for VMC race clip-on
adattabile ai nostri semimanubri

TMA11 adaptable for VMC handlebars
adattabile ai nostri manubri

BIKE MODEL	YEAR	CODE	BIKE MODEL	YEAR	CODE
APRILIA			DUCATI		
RSV 1000 / TUONO	98-08	TMA10	MONSTER 696 / 796	08-14	TMA10
RSV 4 / APRC	09-17	TMA10	DIAVEL	11-17	TMA11
BMW			SCRAMBLER	15-16	TMA10
S 1000 R / RR	09-17	TMA25	HONDA		
F 800 R	09-14	TMA26	CBR 600 F	95-13	TMA01
DUCATI			CBR 600 RR / ABS	03-16	TMA01
748 / 916 / 996 / 998	93-03	TMA10	CBR 1000 RR / ABS	04-17	TMA01
749 / 999	03-06	TMA10	VTR 1000 SP1 / 2	00-06	TMA01
848	08-13	TMA28	HORNET 600	98-13	TMA01
1098 / 1198	07-11	TMA10	HORNET 900	02-06	TMA01
MONSTER 696 / 796	08-15	TMA10	CB 1000 R	08-17	TMA01
MONSTER S4R / S2R	01-08	TMA04	KAWASAKI		
STREET FIGHTER 848 / 1100	09-15	TMA11	NINJA 250 R	07-13	TMA04
MONSTER 1100	09-13	TMA11	NINJA 300 R	12-17	TMA04
PANIGALE 1199 / 899	12-15	TMA10	ZX 6-636 R/RR	98-06	TMA04
				07-08	TMA18
				09-17	TMA23

Application list continue



Cod. TM02

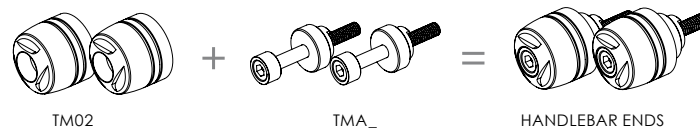

Mounting kit sold separately / Kit attacchi venduti separatamente



Cod. TMA_



BIKE MODEL	YEAR	CODE	BIKE MODEL	YEAR	CODE
KAWASAKI			MV AGUSTA		
ZX 9 R	98-05	TMA04	F4	10-17	TMA35
ZX 10 R	04-15	TMA18	F3	11-17	TMA35
	16-17	TMA23	DRAGSTER	14-17	TMA35
ZZR 1400 R	06-17	TMA04	B3	11-17	TMA37
ER6N	05-08	TMA04	SUZUKI		
	09-16	TMA23	GSX 600 / 750 R	01-03	TMA09
Z 650	2017	TMA34		04-05	TMA02
Z 750 / R	03-13	TMA04		06-17	TMA15
Z 800 / R	13-16	TMA04	GSX 1000 R	01-02	TMA09
Z 900	2017	TMA04		03-04	TMA02
Z 1000	03-17	TMA04		05-16	TMA15
Z 1000 SX	07-16	TMA04		2017	TMA36
			GSXS 750	2017	TMA02
			GSXS 1000	15-17	TMA10
			GSX 1300 R HAYABUSA	08-17	TMA02

MODEL	CODE
"Touring" handlebars ends Terminali manubrio "Touring"	TM02

- Material: aluminum alloy, 180gr
 - Replace the original handlebar ends
 - Recommended for tourist use
 - Inside system anti vibration thanks to a pivot in Avp 65 gr
 - Improves comfort and reduces fatigue on long distance
-
- Materiale: lega di alluminio, 180gr
 - Sostituiscono i terminali manubrio originali
 - Consigliato per uso turistico
 - Sistema interno antivibrazioni grazie ad un peso in Avp 65 gr
 - Migliora il comfort e riduce l'affaticamento sulle lunghe distanze

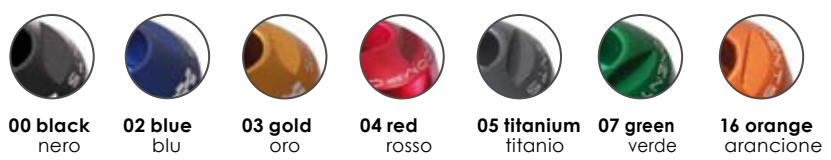
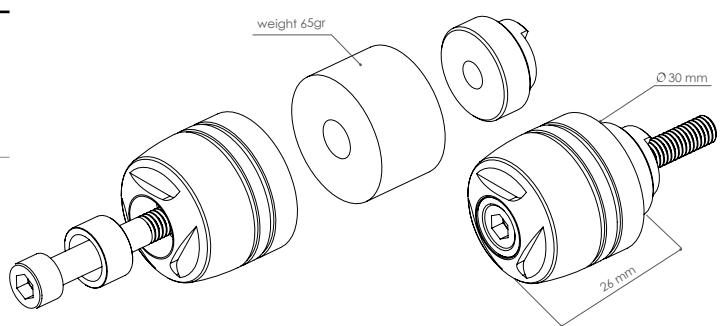

NOTE

TMA10 adattabler for VMC race clip-on adattabile ai nostri semimanubri

TMA11 adattabler for VMC handlebars adattabile ai nostri manubri

ADAPTER	Ø	CODE
handlebars adapter	Ø 11	TMA28
handlebars adapter	Ø 13	TMA11
handlebars adapter	Ø 16	TMA10
handlebars adapter	Ø 18	TMA29

Application list continue





Cod. TM03

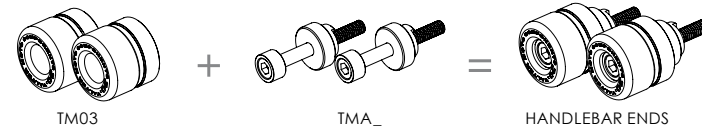

Mounting kit sold separately / Kit attacchi venduti separatamente

BIKE MODEL	YEAR	CODE
SUZUKI		
GSR 600	06-12	TMA09
GSR 750	10-16	TMA02
GLADIUS 650	09-15	TMA24
SV 1000	03-06	TMA02
SV650 ABS	99-02	TMA09
	03-12	TMA02
	16-17	TMA10
B-KING	07-12	TMA24
YAMAHA		
R125	08-17	TMA13
R6	99-05	TMA06
	06-17	TMA08
R1	98-01	TMA02
	02-17	TMA08
XJ6	09-15	TMA13
FZ1	06-15	TMA13

BIKE MODEL	YEAR	CODE
YAMAHA		
FZ6	04-11	TMA13
FZ8	10-16	TMA08
FAZER 1000	00-05	TMA13
MT07	14-17	TMA13
MT09	13-16	TMA13
MT10	16-17	TMA13
T-MAX	08-16	TMA13
TDM 900	02-14	TMA13
TRIUMPH		
DAYTONA 675 / R	06-12	TMA19
	13-16	TMA08
STREET TRIPLE / R	07-12	TMA21
	13-16	TMA08
SPEED TRIPLE / R	05-07	TMA16
	08-10	TMA22
	11-15	TMA27



Cod. TMA_

MODEL	CODE
"Track" handlebars ends Terminali manubrio "Track"	TM03

- Material: aluminum alloy and nylon
 - Replace the original handlebar ends
 - Recommended for racing use
 - Inside system anti vibration
 - The nylon part cancels completely the vibrations
- Materiale: lega di alluminio e nylon
 - Sostituiscono i terminali manubrio originali
 - Consigliato per uso pista
 - Sistema interno antivibrazioni
 - La parte in nylon annulla completamente le vibrazioni

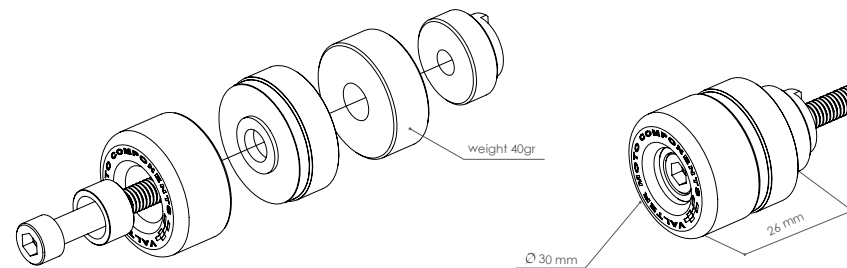

NOTE

TMA10 adaptable for VMC race clip-on
adattabile ai nostri semimanubri

TMA11 adaptable for VMC handlebars
adattabile ai nostri manubri

ADAPTER	Ø	CODE
handlebars adapter	Ø 11	TMA28
handlebars adapter	Ø 13	TMA11
handlebars adapter	Ø 16	TMA10
handlebars adapter	Ø 18	TMA29